

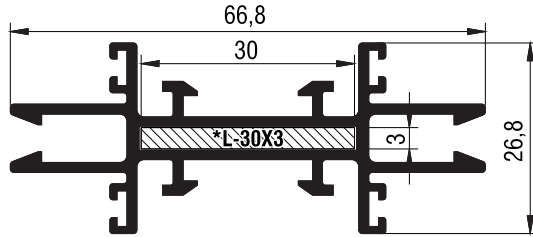

Προφίλ 1:1
Profile 1:1

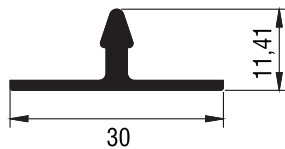

*Σε περίπτωση που χρειάζεται ενίσχυση / In case reinforcement is needed

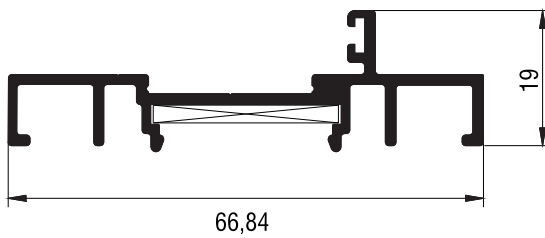
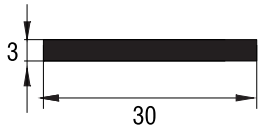

P151	
Κολώνα - Mullion	
Εξωτερική περίμετρος External perimeter	412,6 mm
Κύρια περίμετρος Primary perimeter	0 mm
Ροπή αδρανείας x-x Moment of inertia x-x	1,15 cm ⁴
Ροπή αδρανείας y-y Moment of inertia y-y	11,55 cm ⁴
Βάρος Weight	924 gr/m

*L-30X3	
Ενίσχυση - Reinforcement	
Εξωτερική περίμετρος External perimeter	66 mm
Κύρια περίμετρος Primary perimeter	66 mm
Ροπή αδρανείας x-x Moment of inertia x-x	0,007 cm ⁴
Ροπή αδρανείας y-y Moment of inertia y-y	0,70 cm ⁴
Βάρος Weight	243 gr/m

P153	
Μπινί - Hinged adaption meeting profile	
Εξωτερική περίμετρος External perimeter	278,7 mm
Κύρια περίμετρος Primary perimeter	40,8 mm
Ροπή αδρανείας x-x Moment of inertia x-x	0,31 cm ⁴
Ροπή αδρανείας y-y Moment of inertia y-y	8,94 cm ⁴
Βάρος Weight	574,7 gr/m

P152	
Καπάκι - Cover profile	
Εξωτερική περίμετρος External perimeter	81,3 mm
Κύρια περίμετρος Primary perimeter	32,5 mm
Ροπή αδρανείας x-x Moment of inertia x-x	0,08 cm ⁴
Ροπή αδρανείας y-y Moment of inertia y-y	0,32 cm ⁴
Βάρος Weight	197,8 gr/m

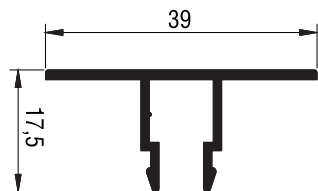

P102	
Κατάκι χωρίσματος - Partition wall cover cap	
Εξωτερική περίμετρος External perimeter	150,5 mm
Κύρια περίμετρος Primary perimeter	42,5 mm
Ροπή αδρανείας x-x Moment of inertia x-x	0,28 cm ⁴
Ροπή αδρανείας y-y Moment of inertia y-y	0,78 cm ⁴
Βάρος Weight	264,4 gr/m

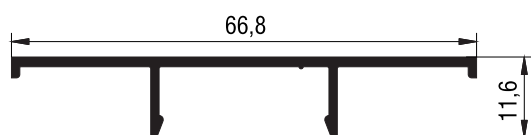

P103	
Κατάκι - Cover profile	
Εξωτερική περίμετρος External perimeter	182,7 mm
Κύρια περίμετρος Primary perimeter	72,8 mm
Ροπή αδρανείας x-x Moment of inertia x-x	0,09 cm ⁴
Ροπή αδρανείας y-y Moment of inertia y-y	4,30 cm ⁴
Βάρος Weight	332,4 gr/m



P124	
Κατάκι Cover profile	
Εξωτερική περίμετρος External perimeter	151 mm
Κύρια περίμετρος Primary perimeter	53 mm
Ροπή αδρανείας x-x Moment of inertia x-x	0,09 cm ⁴
Ροπή αδρανείας y-y Moment of inertia y-y	2,37 cm ⁴
Βάρος Weight	274 gr/m

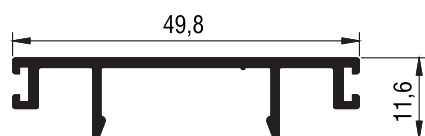

P105	
Κατάκι - Cover profile	
Εξωτερική περίμετρος External perimeter	181,6 mm
Κύρια περίμετρος Primary perimeter	30,3 mm
Ροπή αδρανείας x-x Moment of inertia x-x	0,11 cm ⁴
Ροπή αδρανείας y-y Moment of inertia y-y	3,11 cm ⁴
Βάρος Weight	324,0 gr/m

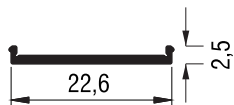

P155	
Καπάκι - Cover profile	
Εξωτερική περίμετρος External perimeter	53,8 mm
Κύρια περίμετρος Primary perimeter	22,8 mm
Ροπή αδρανείας x-x Moment of inertia x-x	0,00 cm ⁴
Ροπή αδρανείας y-y Moment of inertia y-y	0,14 cm ⁴
Βάρος Weight	79 gr/m

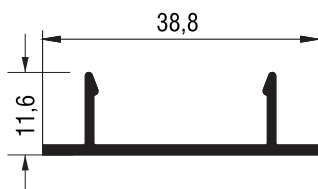

P135	
Καπάκι - Cover profile	
Εξωτερική περίμετρος External perimeter	120,04 mm
Κύρια περίμετρος Primary perimeter	38,8 mm
Ροπή αδρανείας x-x Moment of inertia x-x	0,08 cm ⁴
Ροπή αδρανείας y-y Moment of inertia y-y	1,10 cm ⁴
Βάρος Weight	216,1 gr/m



P104	
Καπάκι - Cover profile	
Εξωτερική περίμετρος External perimeter	182,2 mm
Κύρια περίμετρος Primary perimeter	61,5 mm
Ροπή αδρανείας x-x Moment of inertia x-x	0,10 cm ⁴
Ροπή αδρανείας y-y Moment of inertia y-y	3,70 cm ⁴
Βάρος Weight	328,2 gr/m

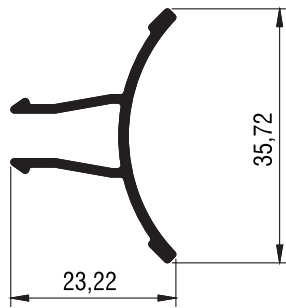

P131	
Καπάκι χωρίσματος - Partition wall cover cap	
Εξωτερική περίμετρος External perimeter	143,3 mm
Κύρια περίμετρος Primary perimeter	37,5 mm
Ροπή αδρανείας x-x Moment of inertia x-x	0,78 cm ⁴
Ροπή αδρανείας y-y Moment of inertia y-y	0,39 cm ⁴
Βάρος Weight	264,1 gr/m

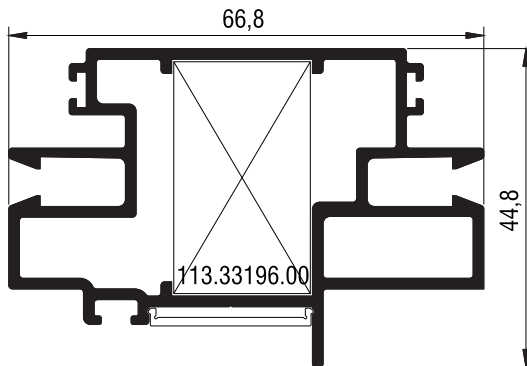

P154	
Φύλλο - Sash profile	
Εξωτερική περίμετρος External perimeter	342,7 mm
Κύρια περίμετρος Primary perimeter	112,8 mm
Ροπή αδρανείας x-x Moment of inertia x-x	7,27 cm ⁴
Ροπή αδρανείας y-y Moment of inertia y-y	19,58 cm ⁴
Βάρος Weight	1222,1 gr/m
Γωνία Σύνδεσης πρεσαριστή Crimp nail cleat	113-33-196-00

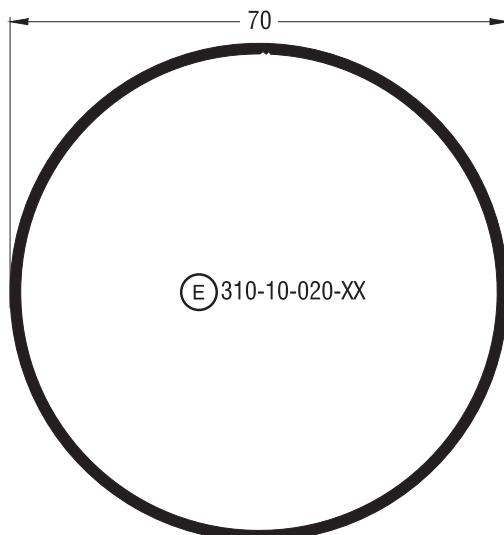

T35	
Κολώνα - Mullion	
Εξωτερική περίμετρος External perimeter	220 mm
Κύρια περίμετρος Primary perimeter	220 mm
Ροπή αδρανείας x-x Moment of inertia x-x	18,91 cm ⁴
Ροπή αδρανείας y-y Moment of inertia y-y	18,94 cm ⁴
Βάρος Weight	871 gr/m
Τάπα End cap	310-10-020-XX

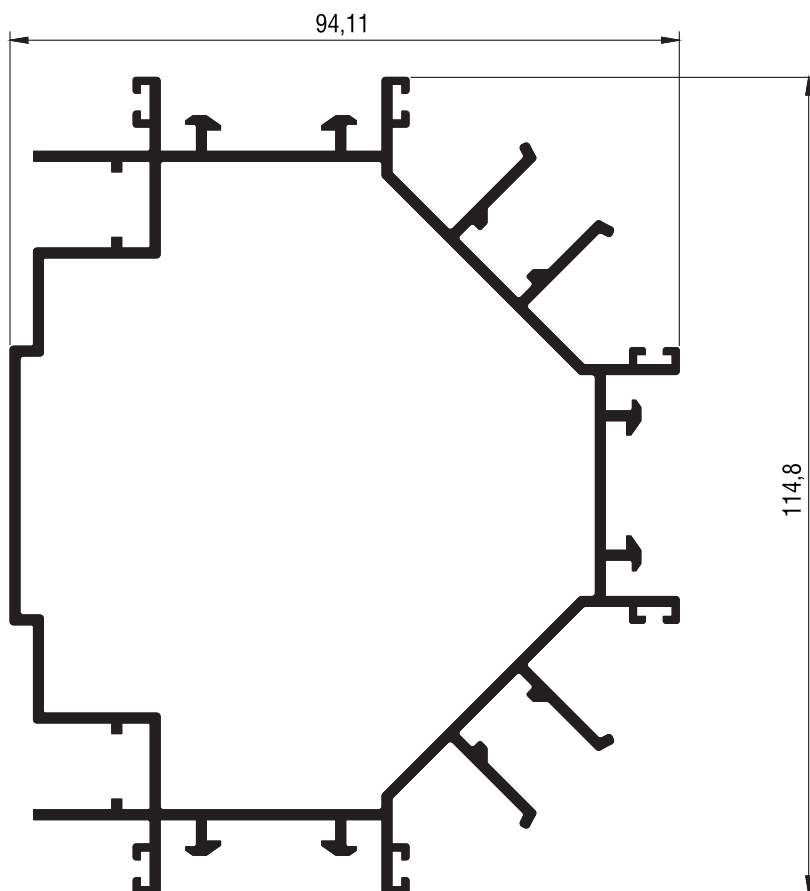

P128	
Κολώνα χωρίσματος - Partition wall profile	
Εξωτερική περίμετρος External perimeter	840,7 mm
Κύρια περίμετρος Primary perimeter	39,8 mm
Ροπή αδρανείας x-x Moment of inertia x-x	109,48 cm ⁴
Ροπή αδρανείας y-y Moment of inertia y-y	72,09 cm ⁴
Βάρος Weight	2177,4 gr/m

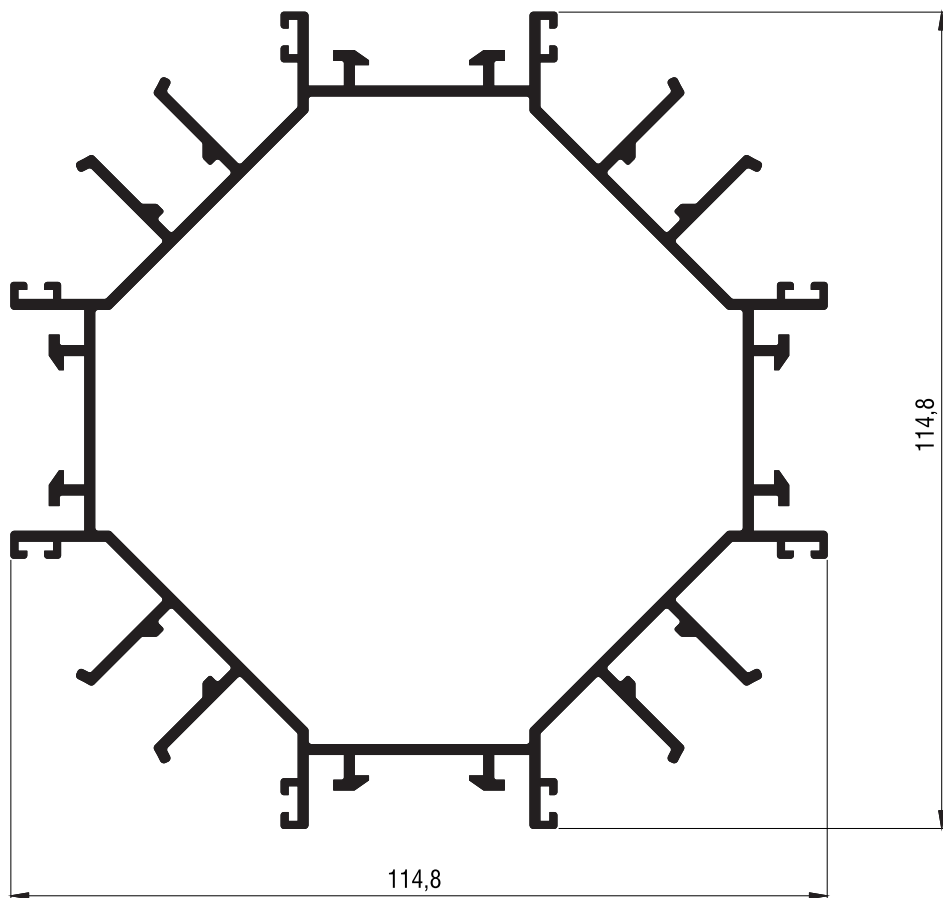

P129	
Κολώνα χωρίσματος - Partition wall profile	
Εξωτερική περίμετρος External perimeter	999,6 mm
Κύρια περίμετρος Primary perimeter	0 mm
Ροπή αδρανείας x-x Moment of inertia x-x	113,37 cm ⁴
Ροπή αδρανείας y-y Moment of inertia y-y	113,37 cm ⁴
Βάρος Weight	2477,1 gr/m

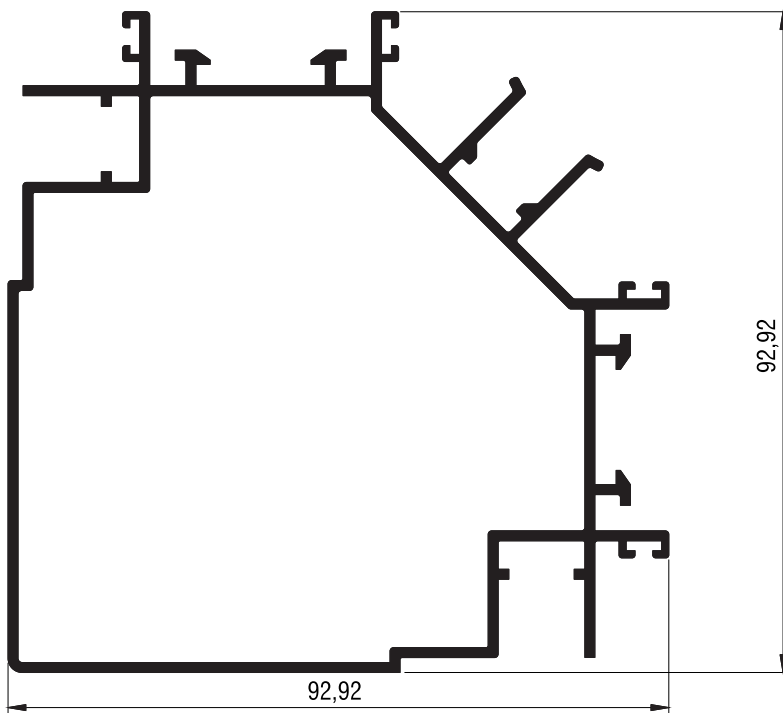

P127	
Κολώνα χωρίσματος - Partition wall profile	
Εξωτερική περίμετρος External perimeter	661,7 mm
Κύρια περίμετρος Primary perimeter	113,7 mm
Ροπή αδρανείας x-x Moment of inertia x-x	65,21 cm ⁴
Ροπή αδρανείας y-y Moment of inertia y-y	65,21 cm ⁴
Βάρος Weight	1820,7 gr/m

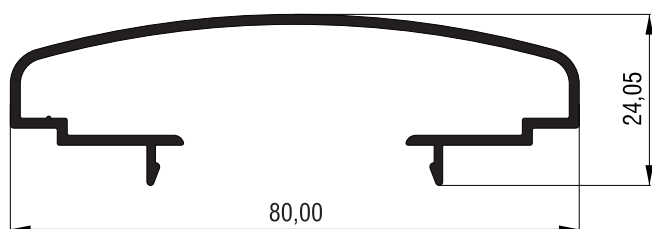

P106	
Πρόσθετο - Additional profile	
Εξωτερική περίμετρος External perimeter	317,5 mm
Κύρια περίμετρος Primary perimeter	99,6 mm
Ροπή αδρανείας x-x Moment of inertia x-x	1,20 cm ⁴
Ροπή αδρανείας y-y Moment of inertia y-y	15,80 cm ⁴
Βάρος Weight	595,6 gr/m

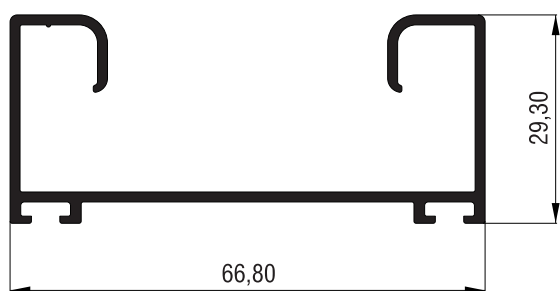

P109	
Πρόσθετο - Additional profile	
Εξωτερική περίμετρος External perimeter	349,6 mm
Κύρια περίμετρος Primary perimeter	164,5 mm
Ροπή αδρανείας x-x Moment of inertia x-x	2,62 cm ⁴
Ροπή αδρανείας y-y Moment of inertia y-y	16,18 cm ⁴
Βάρος Weight	658,2 gr/m

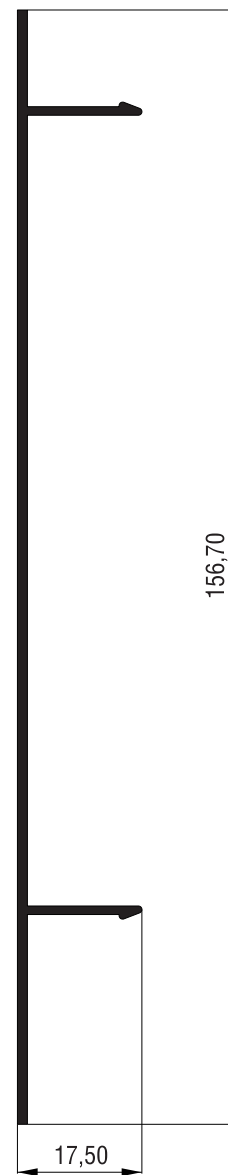
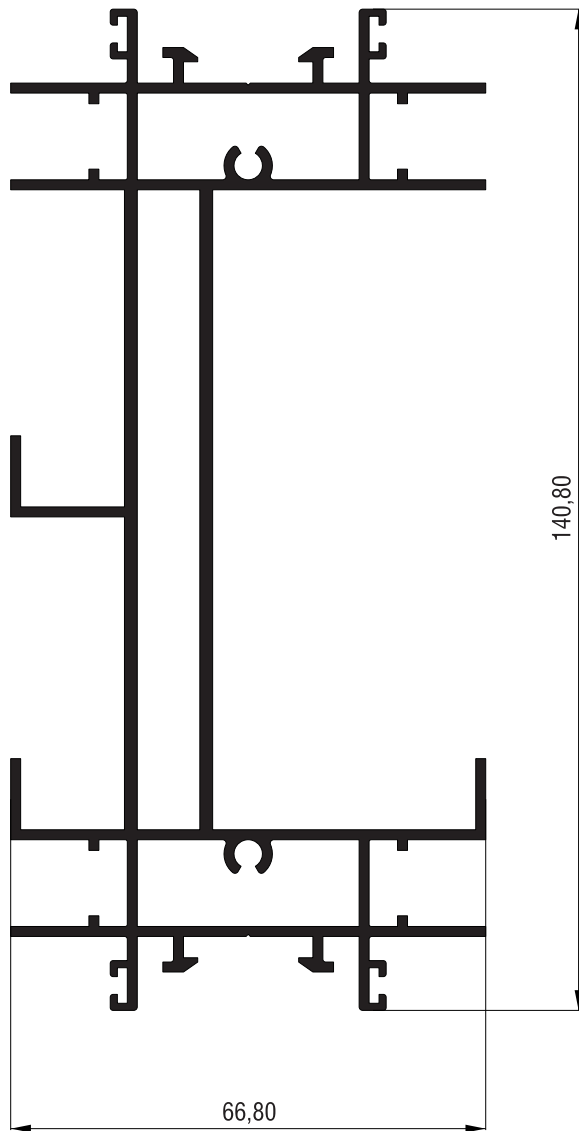

P114	
Πρόσθετο - Additional profile	
Εξωτερική περίμετρος External perimeter	929,9 mm
Κύρια περίμετρος Primary perimeter	0 mm
Ροπή αδρανείας x-x Moment of inertia x-x	217,90 cm ⁴
Ροπή αδρανείας y-y Moment of inertia y-y	28,33 cm ⁴
Βάρος Weight	2728,2 gr/m

P115	
Καπάκι - Cover profile	
Εξωτερική περίμετρος External perimeter	380,5 mm
Κύρια περίμετρος Primary perimeter	156,7 mm
Ροπή αδρανείας x-x Moment of inertia x-x	57,72 cm ⁴
Ροπή αδρανείας y-y Moment of inertia y-y	0,36 cm ⁴
Βάρος Weight	700,1 gr/m

A large, abstract graphic on the left side of the page, composed of several overlapping yellow and orange geometric shapes, including triangles and parallelograms, creating a dynamic, angular composition.

Βασικές Τυπολογίες Basic Typologies

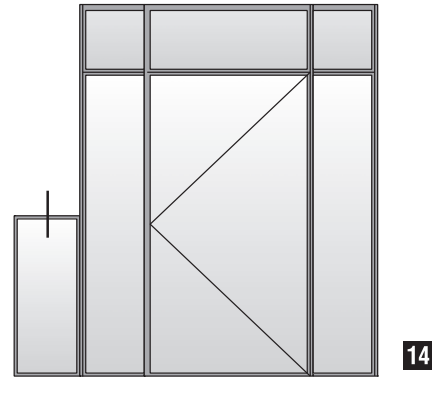
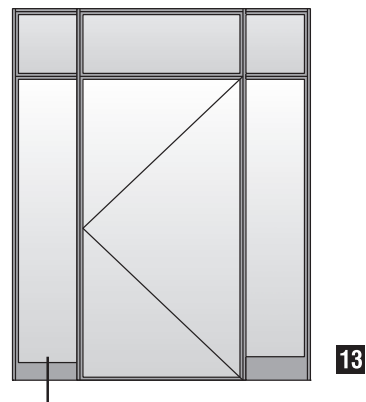
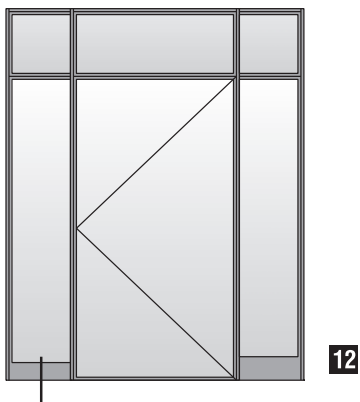
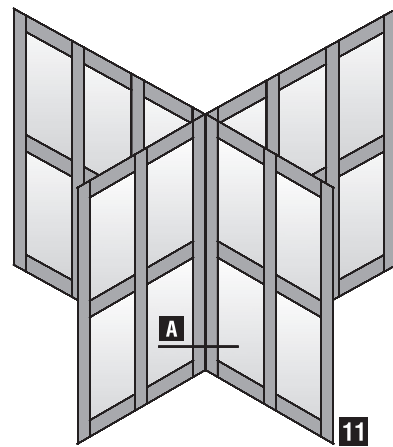
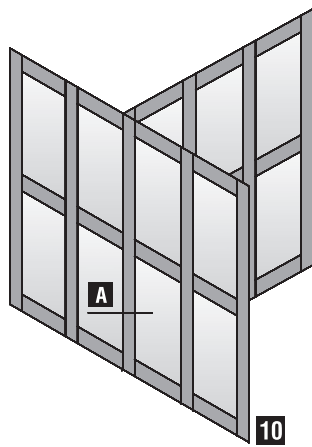
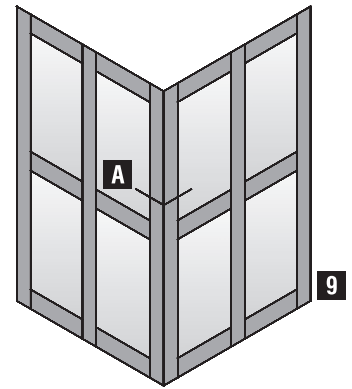
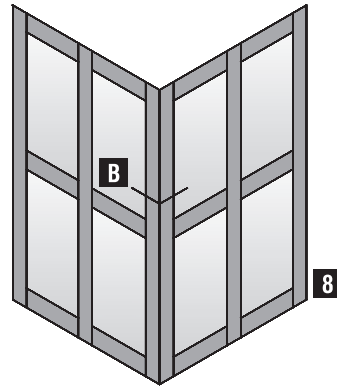
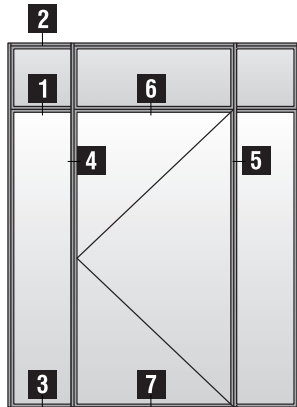



Τομές 1:1
Sections 1:1

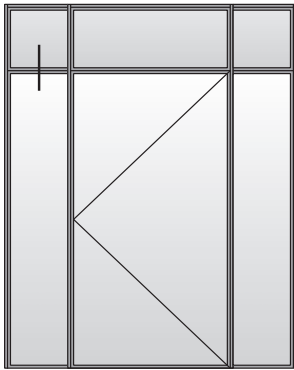

1

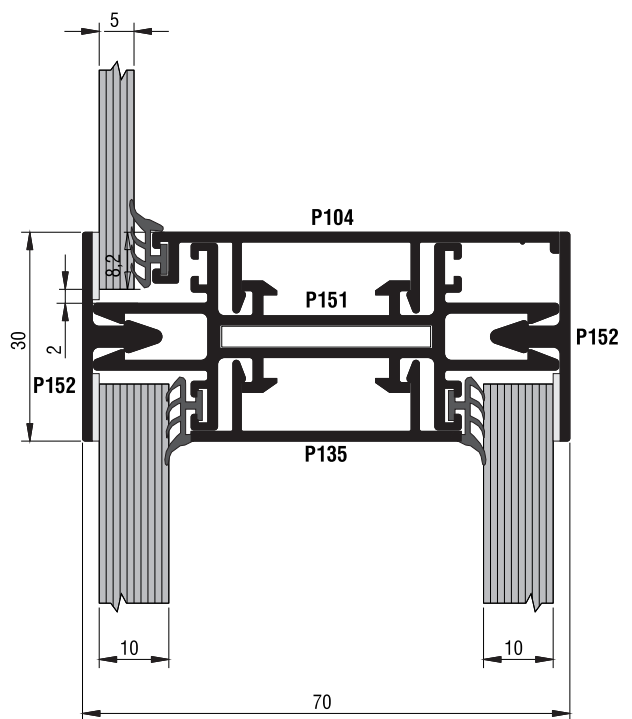
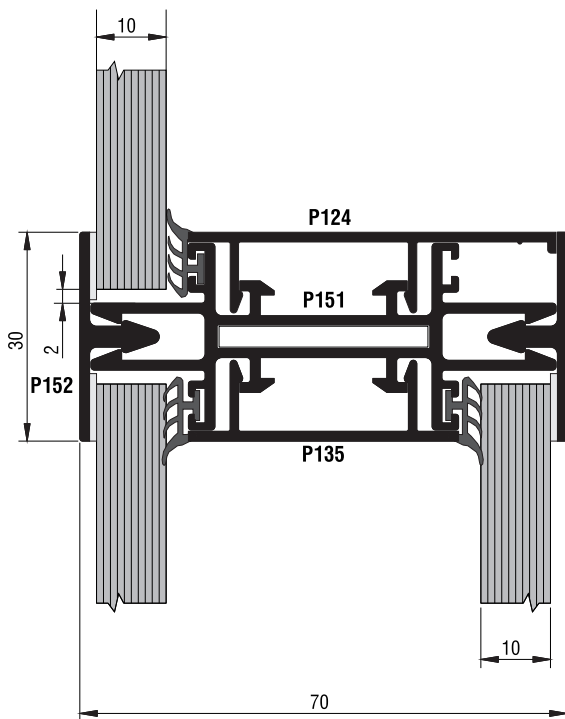
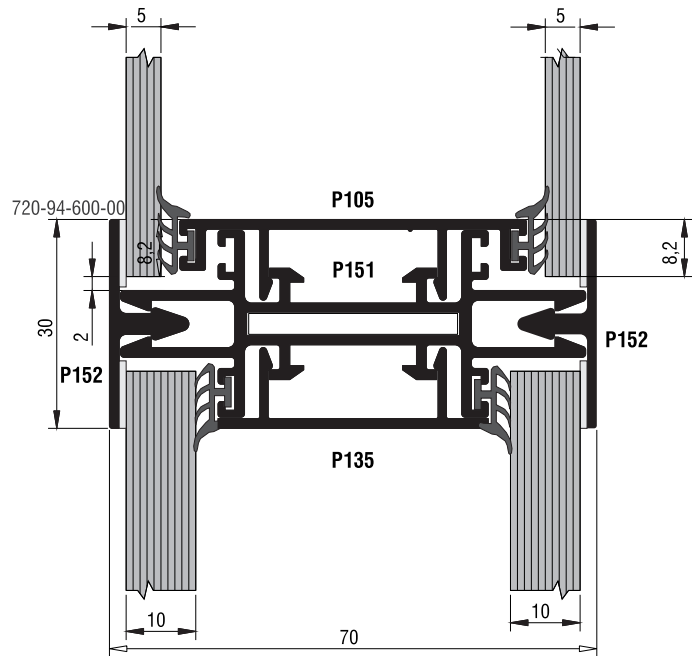

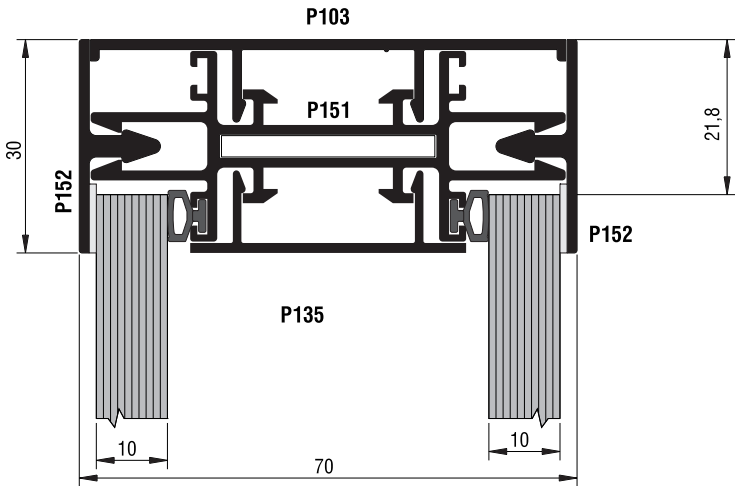
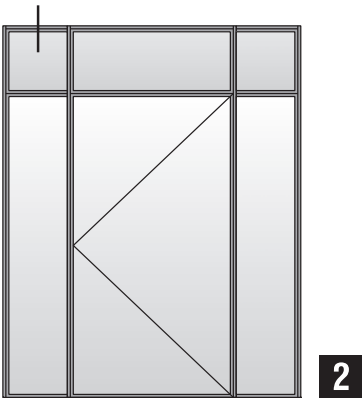

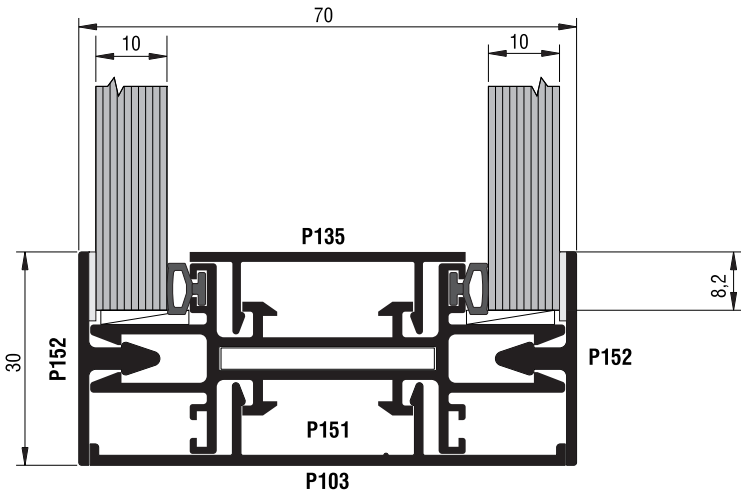
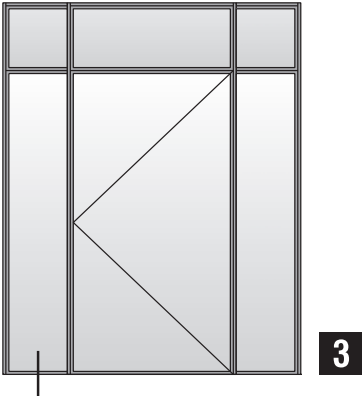

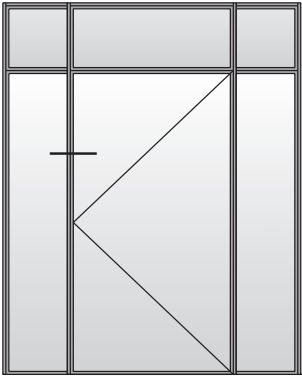

4

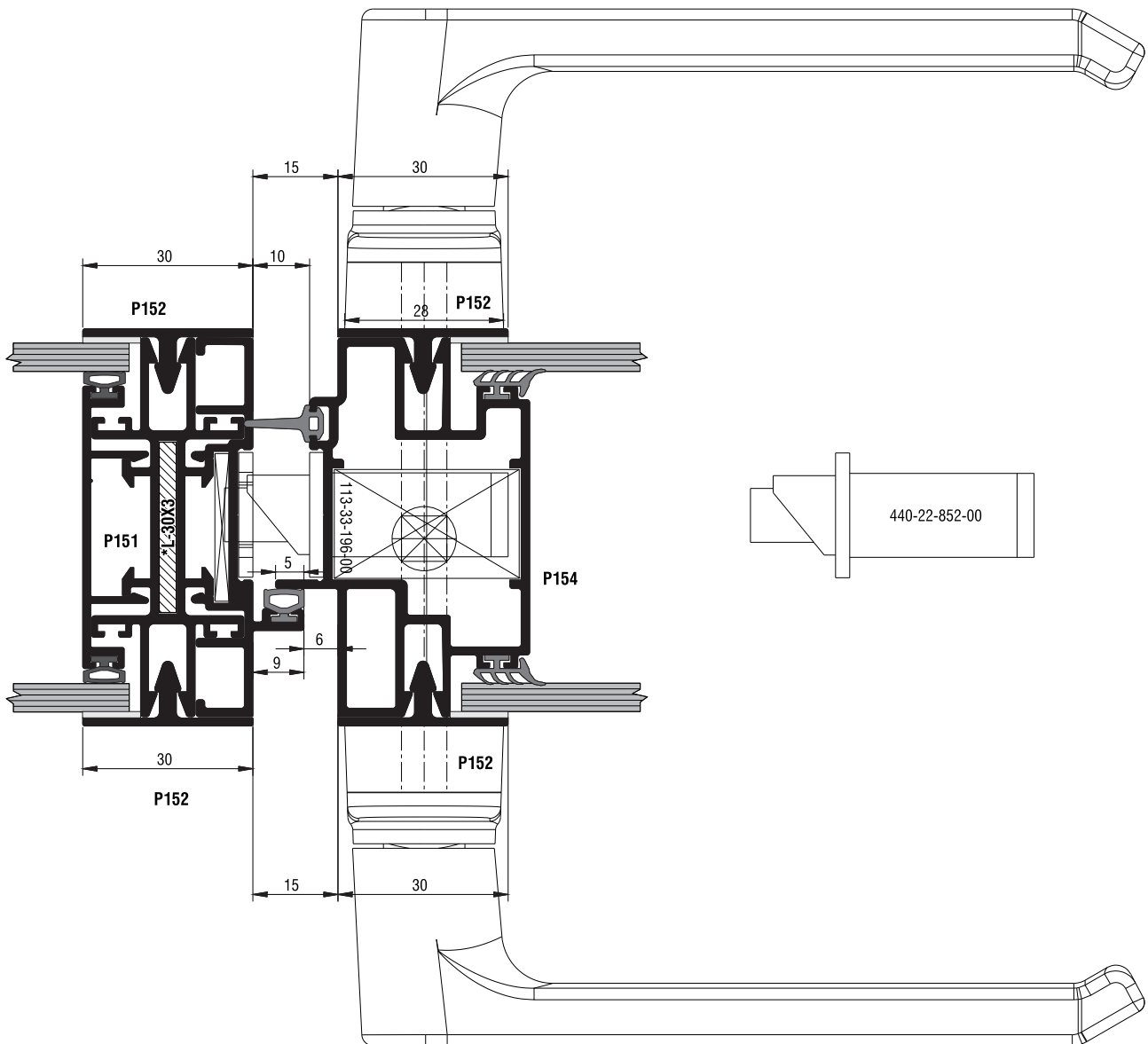

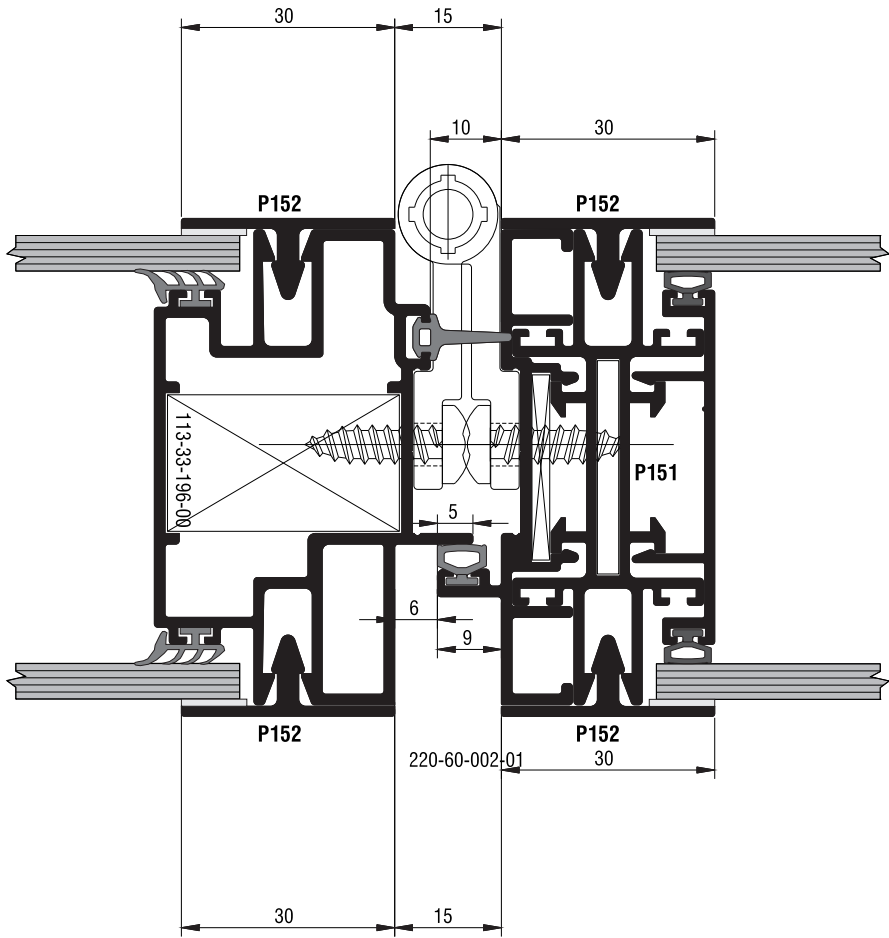
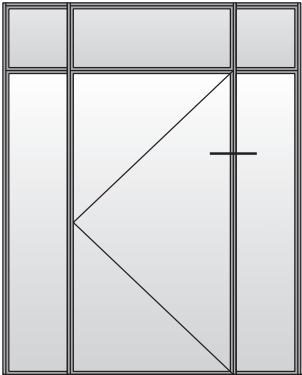

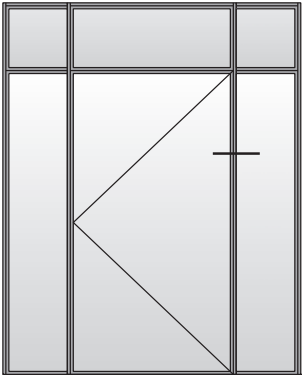

5

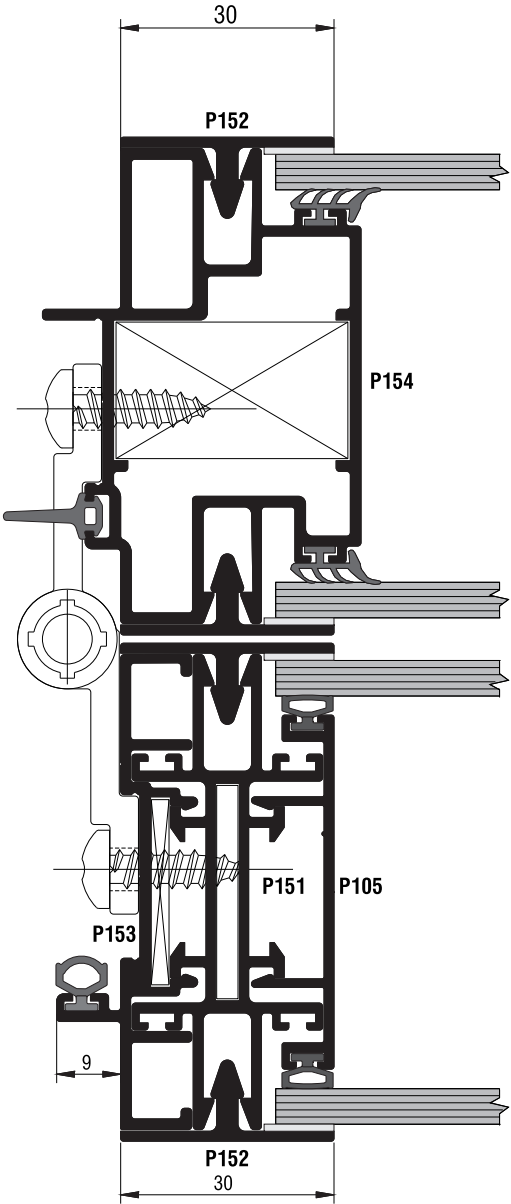

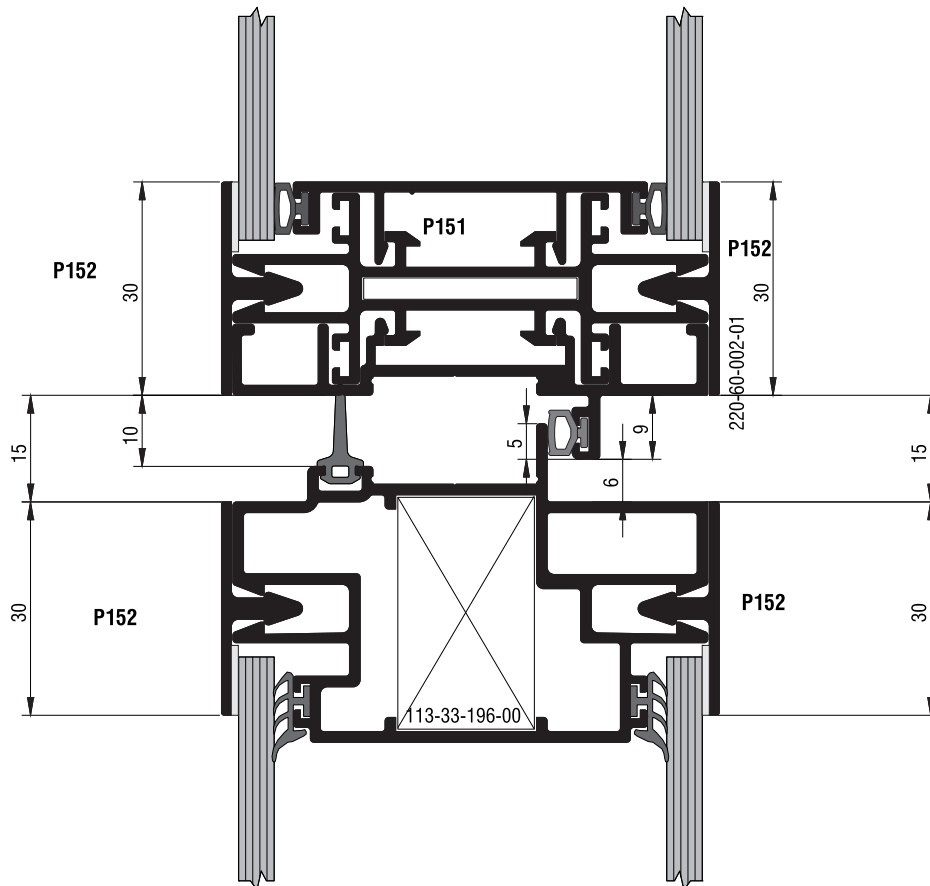
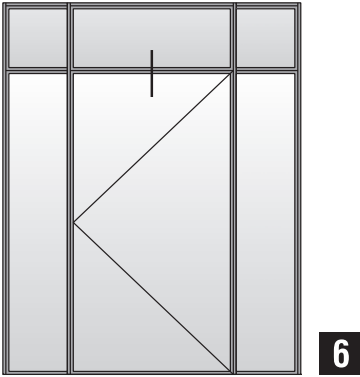

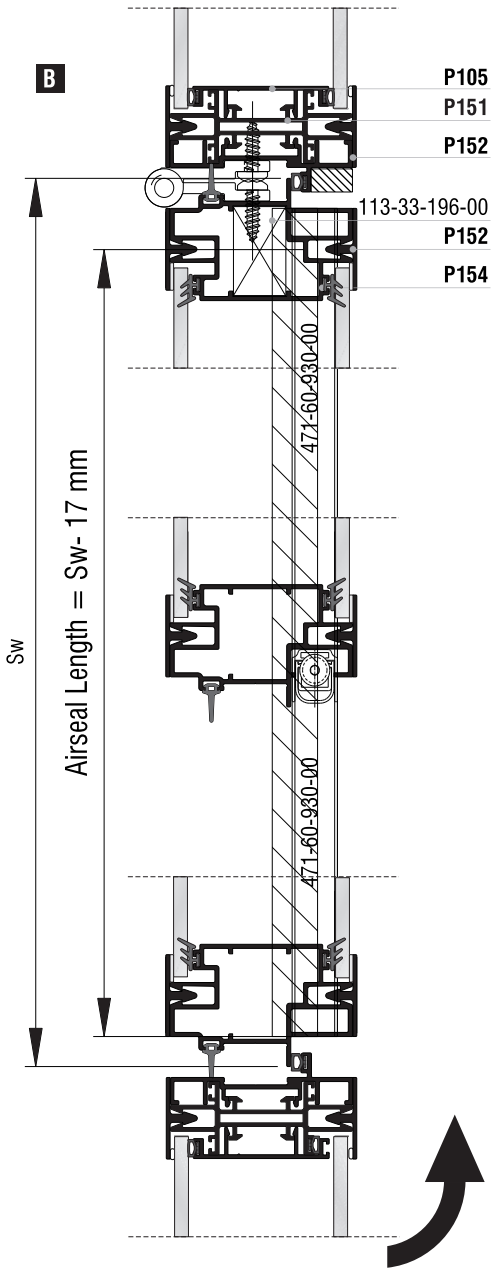
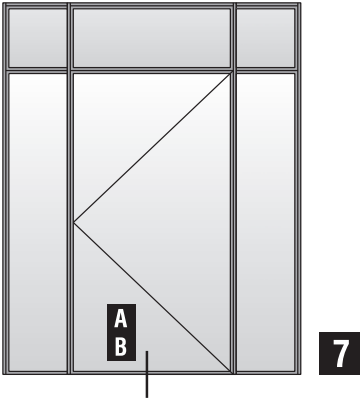

Κάθετη απεικόνιση 90°
Rotate view 90°

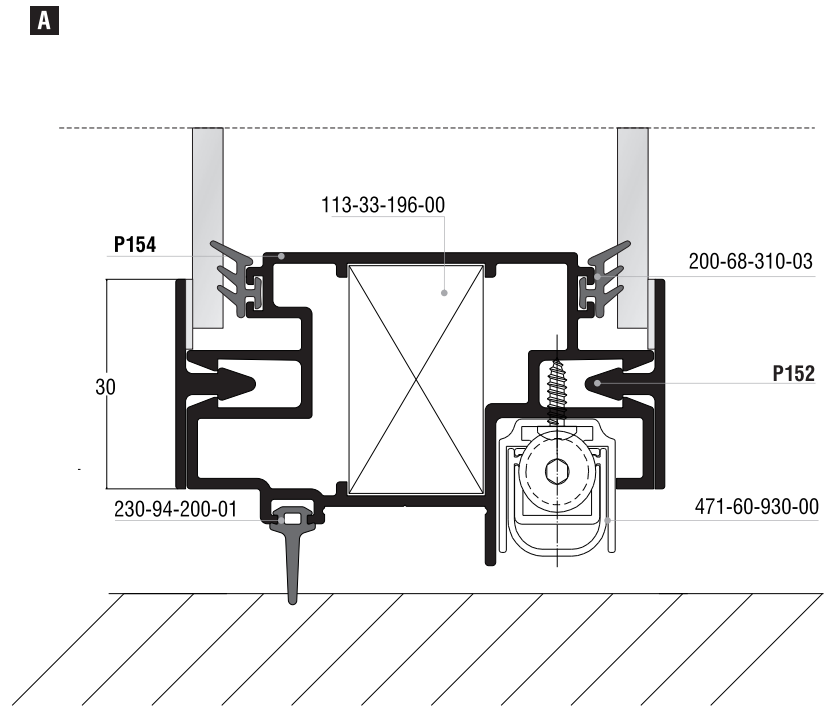

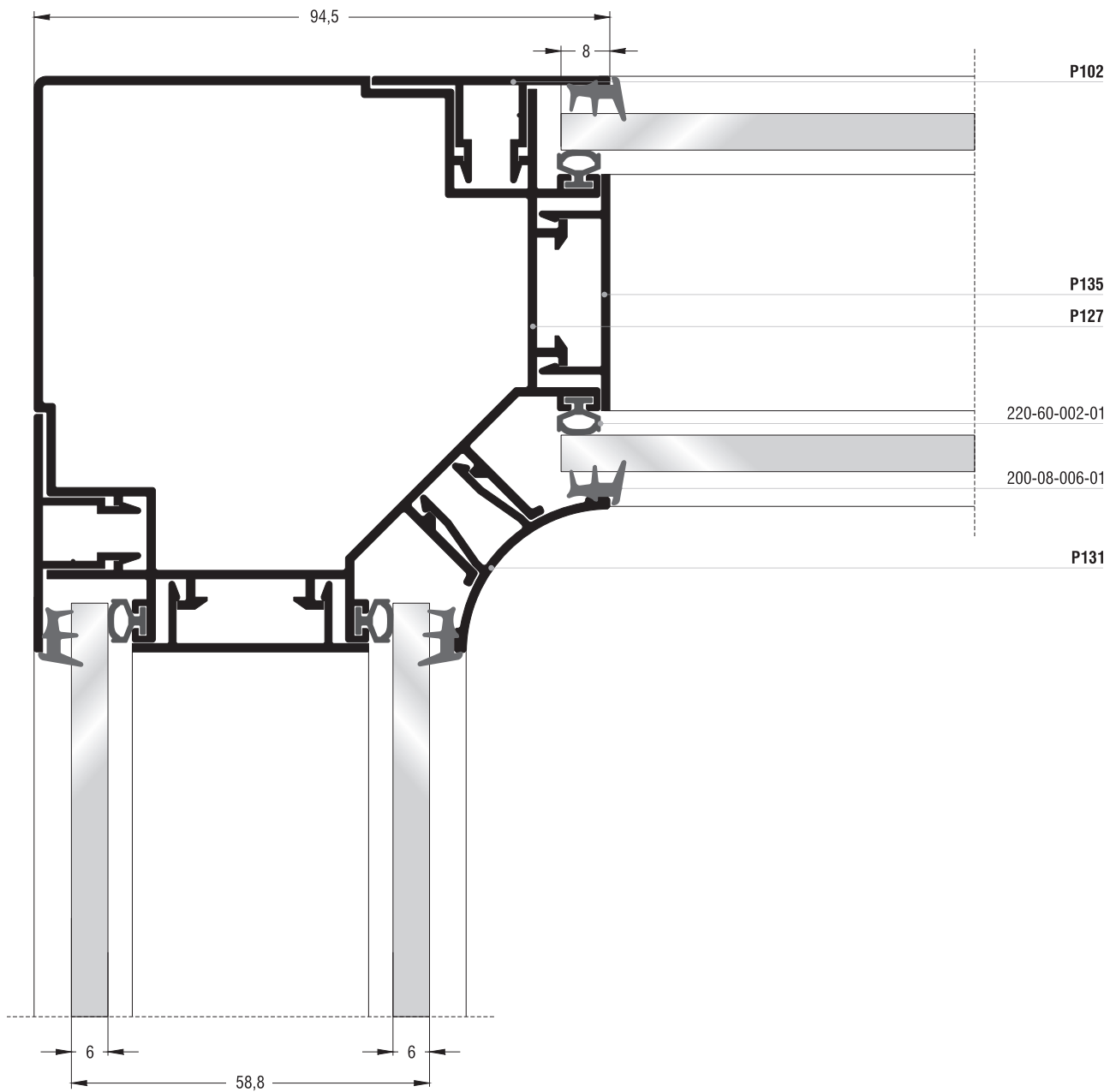
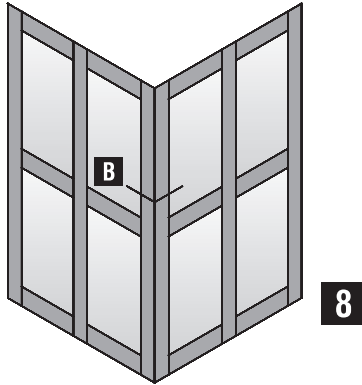

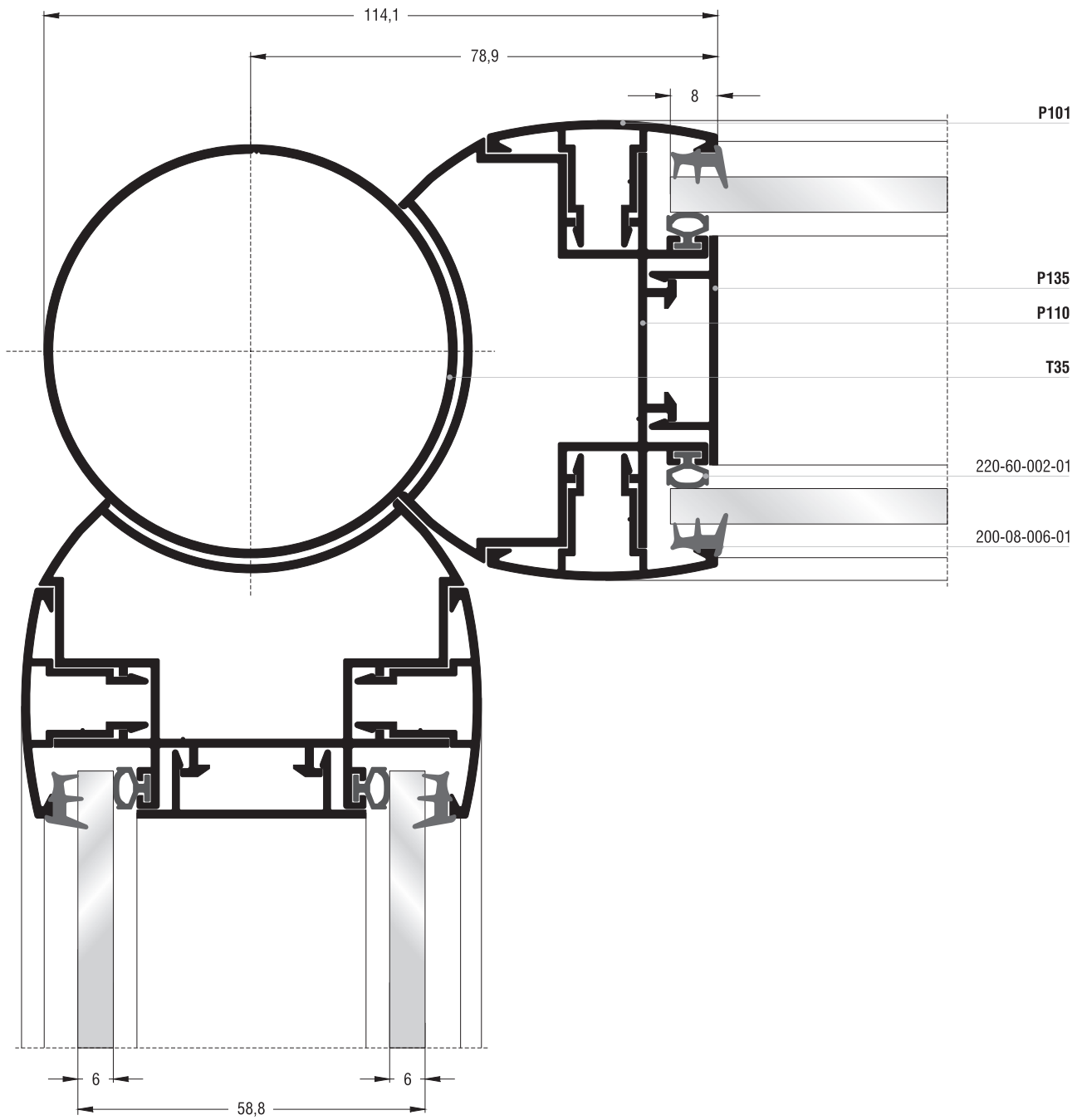
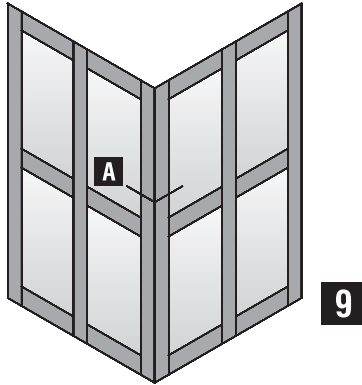

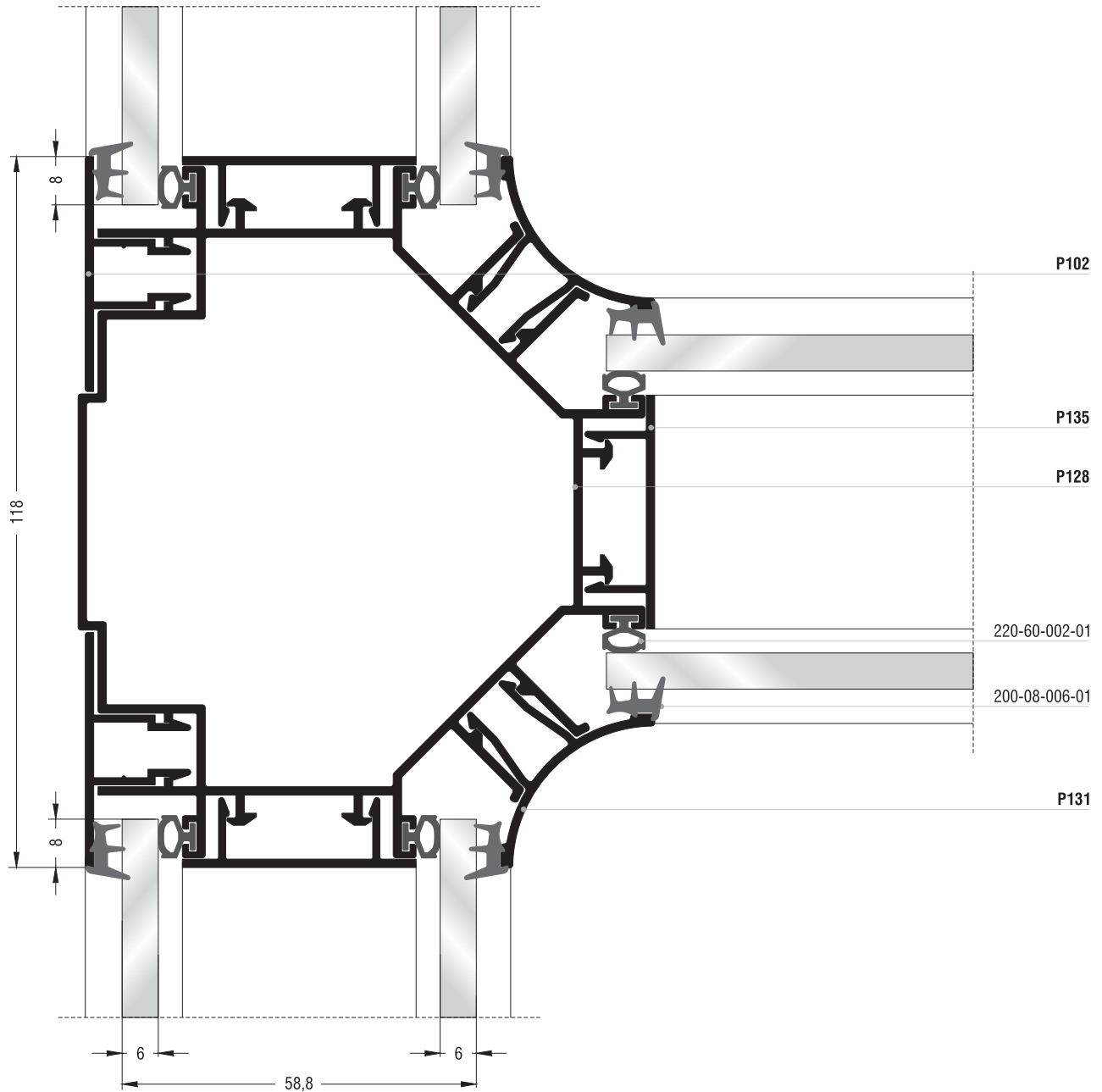
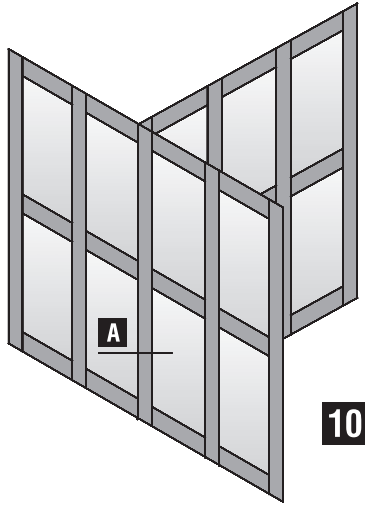

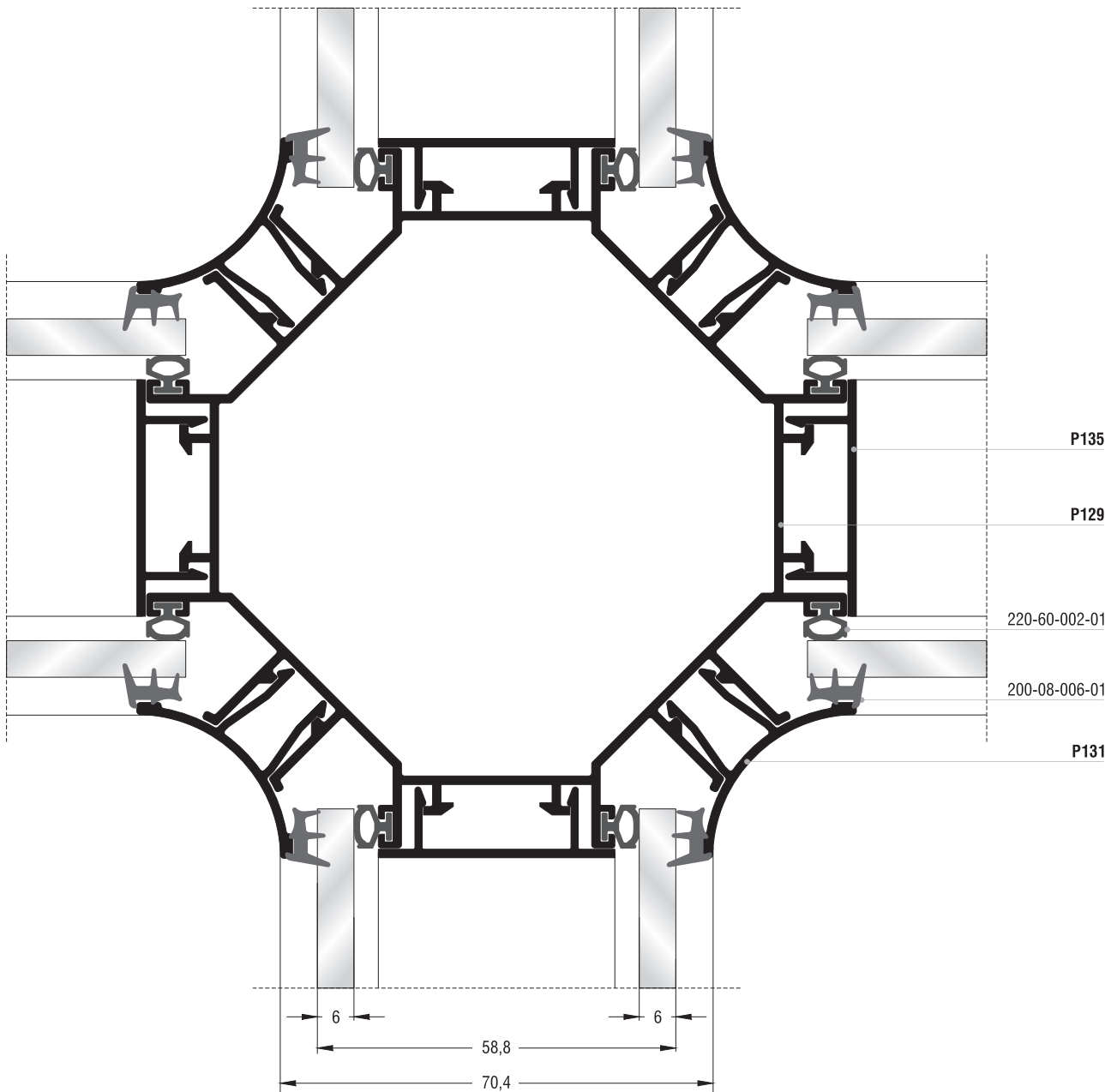
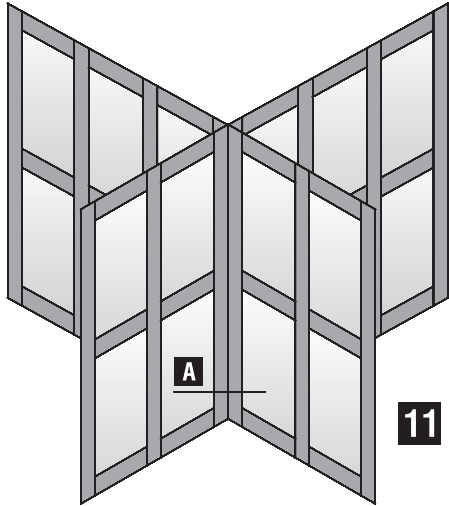

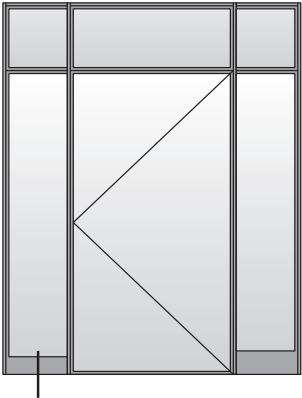

12

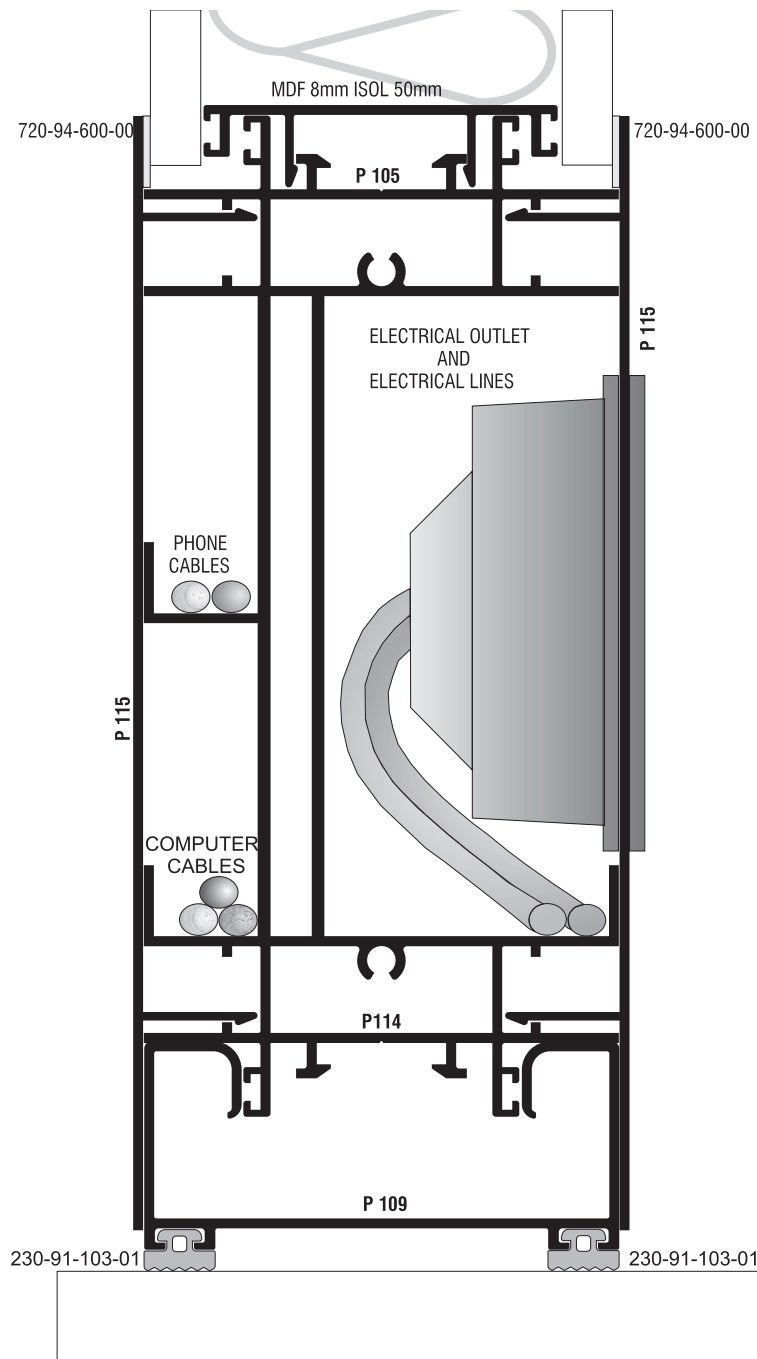

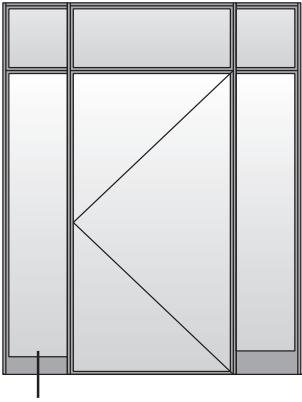

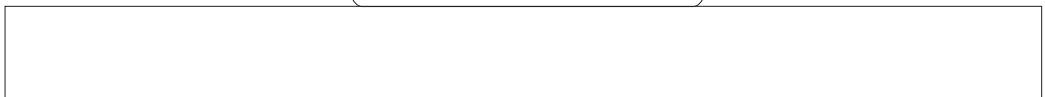
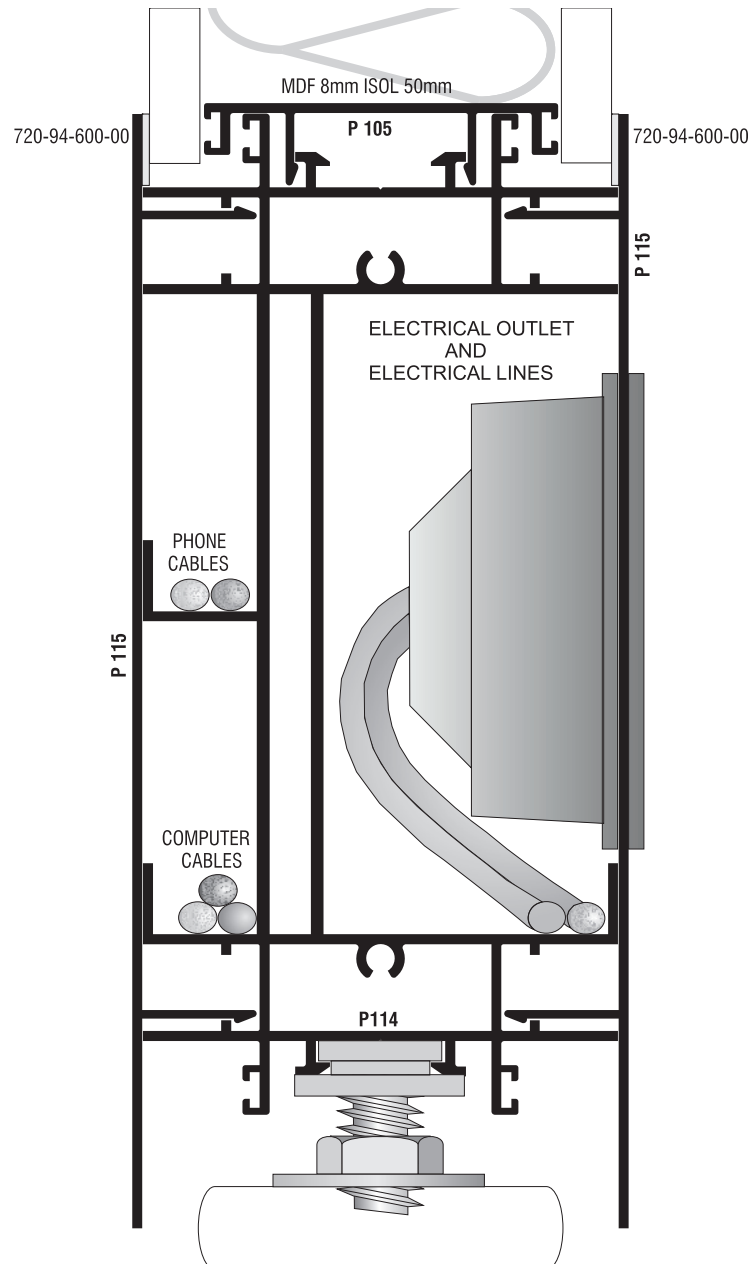

13

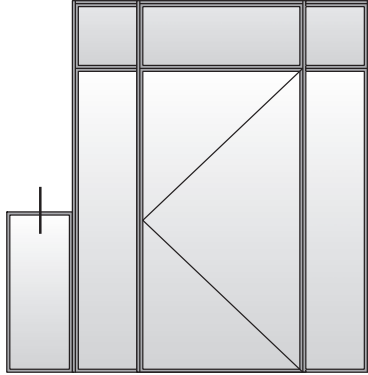

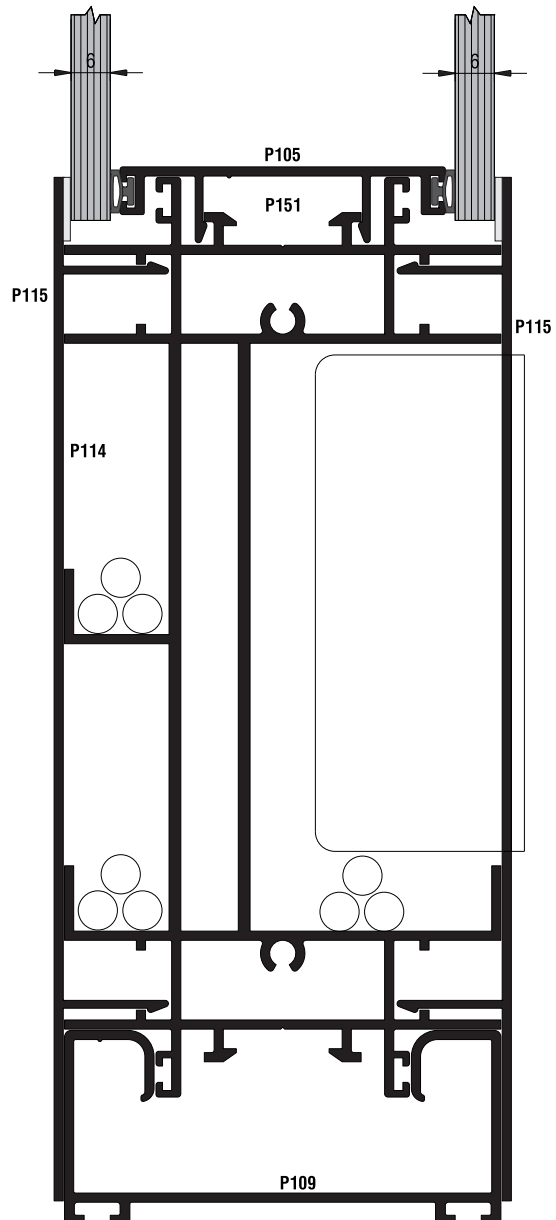
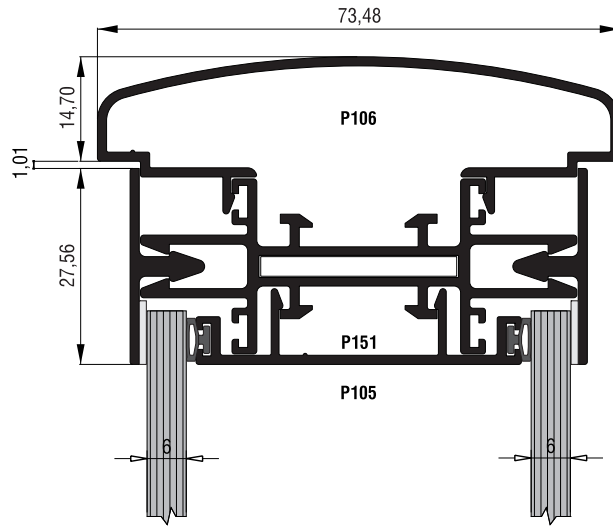

14



A large, abstract graphic on the left side of the page, composed of several overlapping yellow and orange geometric shapes, including triangles and parallelograms, creating a dynamic, angular composition.

Μέτρα Κοπής

Cutting Dies

Code	Profile	Cuttings
P153		1pcs = H-5mm (45 / 90) 1pcs = H-5mm (90 / 45) 1pcs = L-10mm
P154		2pcs = H-23mm (45 / 45) 2pcs = L-38mm (45 / 45)
P152		4pcs = H-45mm 4pcs = L-120mm
GLASS		2pcs = (H-89,1mm) X (L-103,6mm)

A large, abstract graphic on the left side of the page, composed of several overlapping yellow and orange geometric shapes, including triangles and parallelograms, creating a dynamic, angular composition.

Κατεργασίες Milling-Tooling Operations

380-97-610-XX

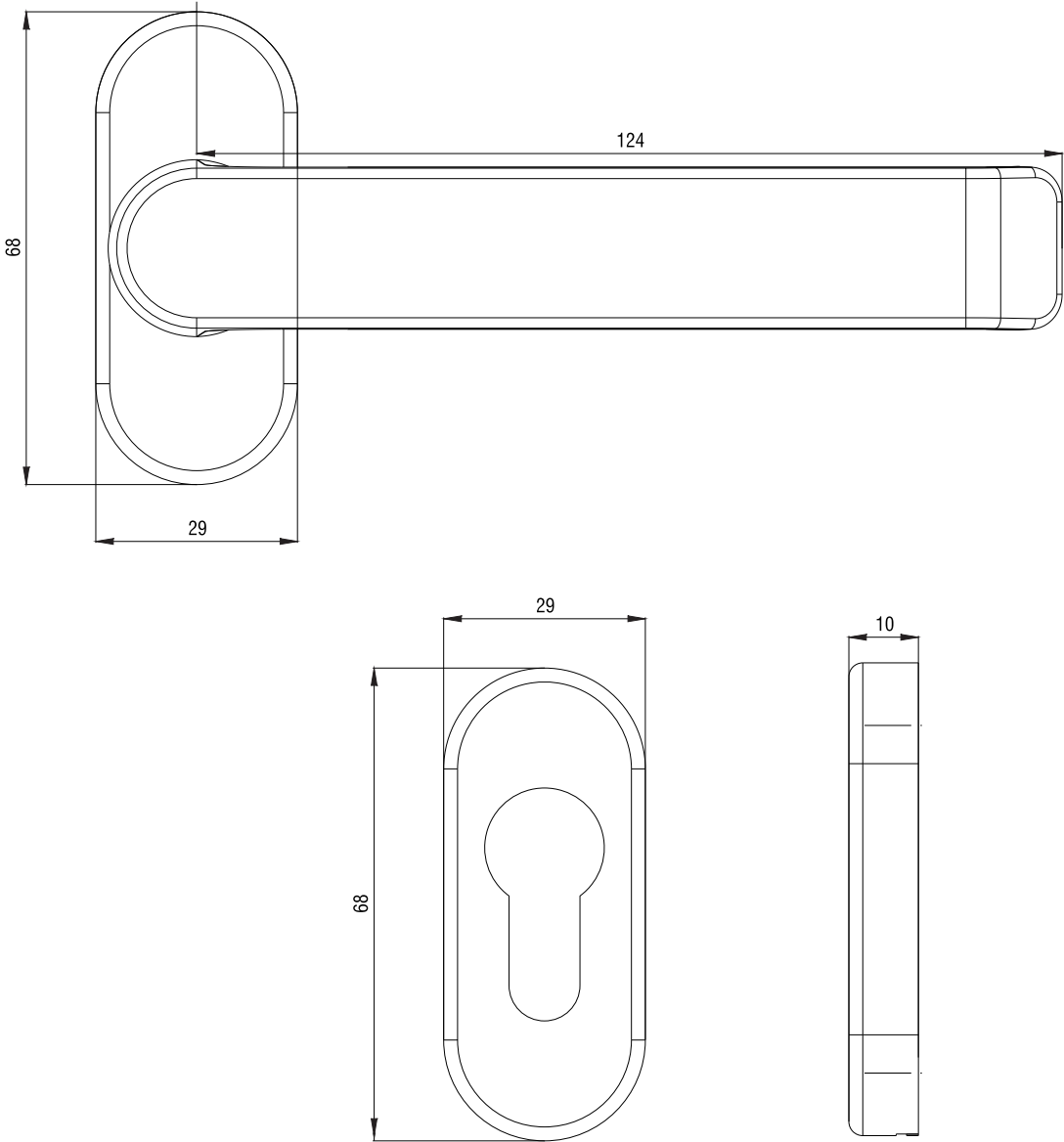

380-05-000-XX

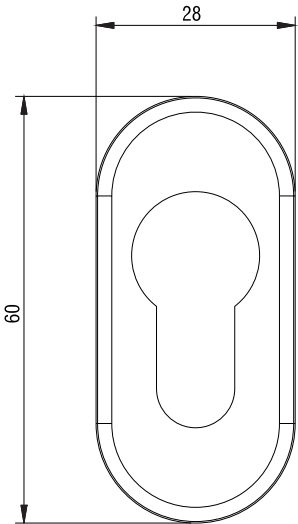
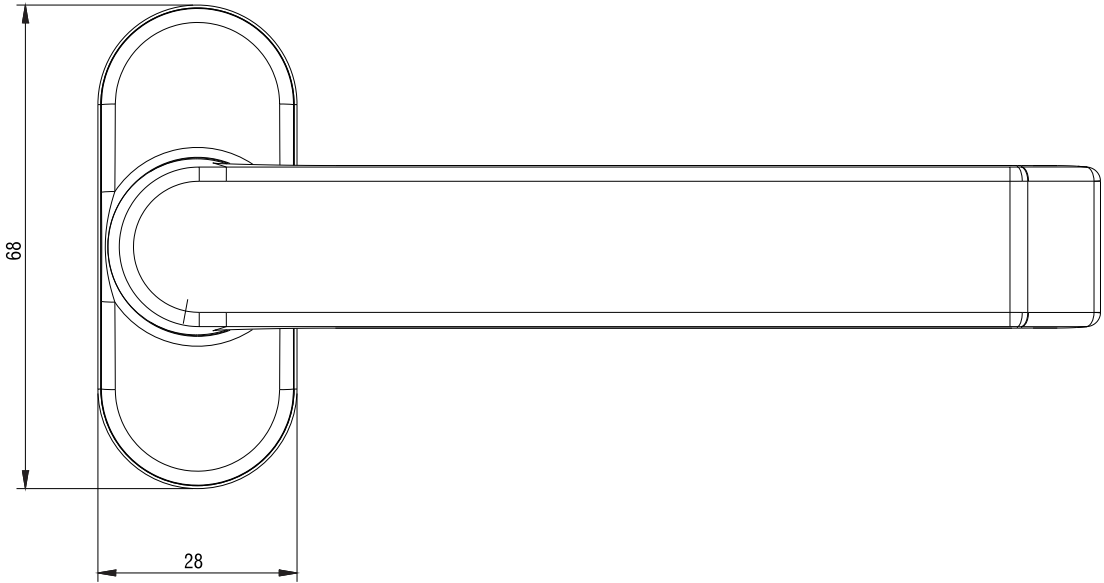

Μεντεσές 350-67-68-000 - Hinge 350-67-68-000

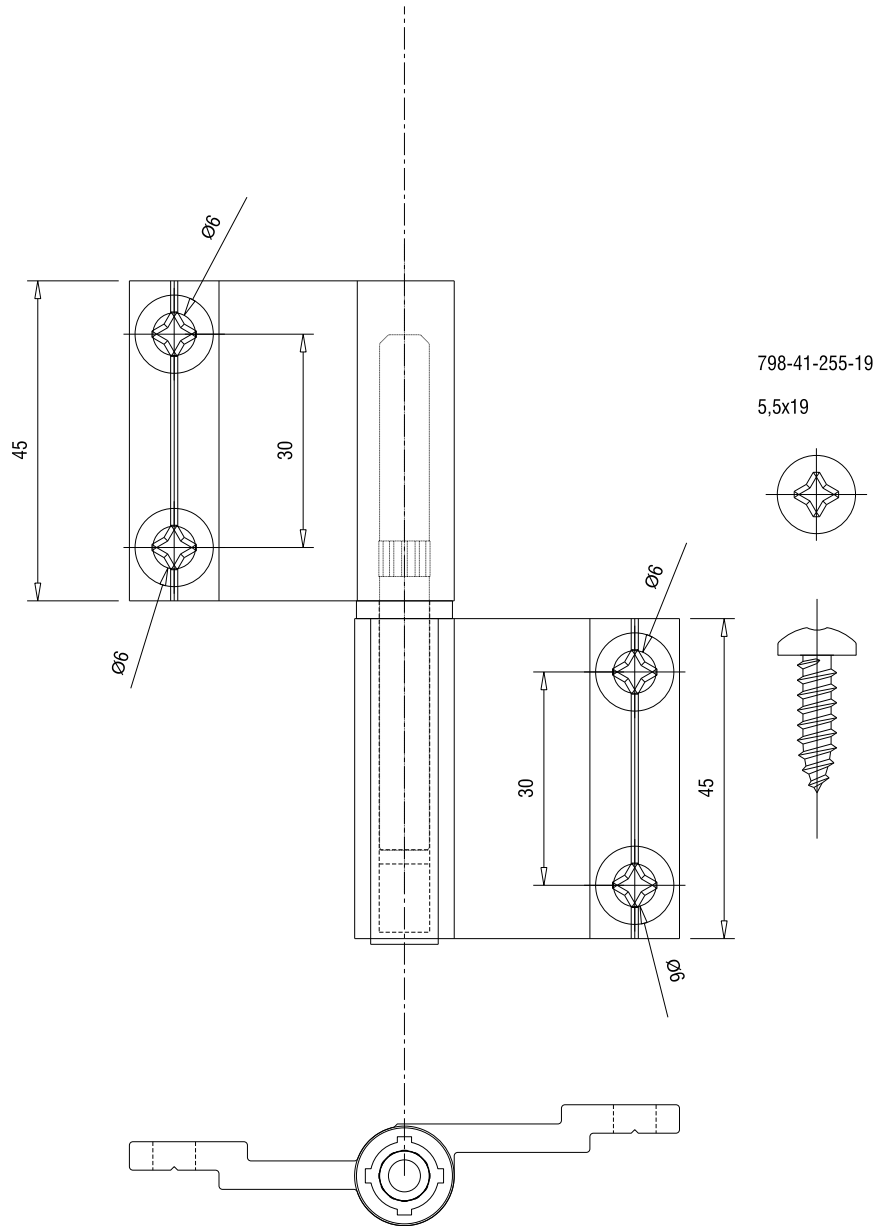

Κατεργασία για ανεμοφράκτη - Tooling operation for waterproof threshold

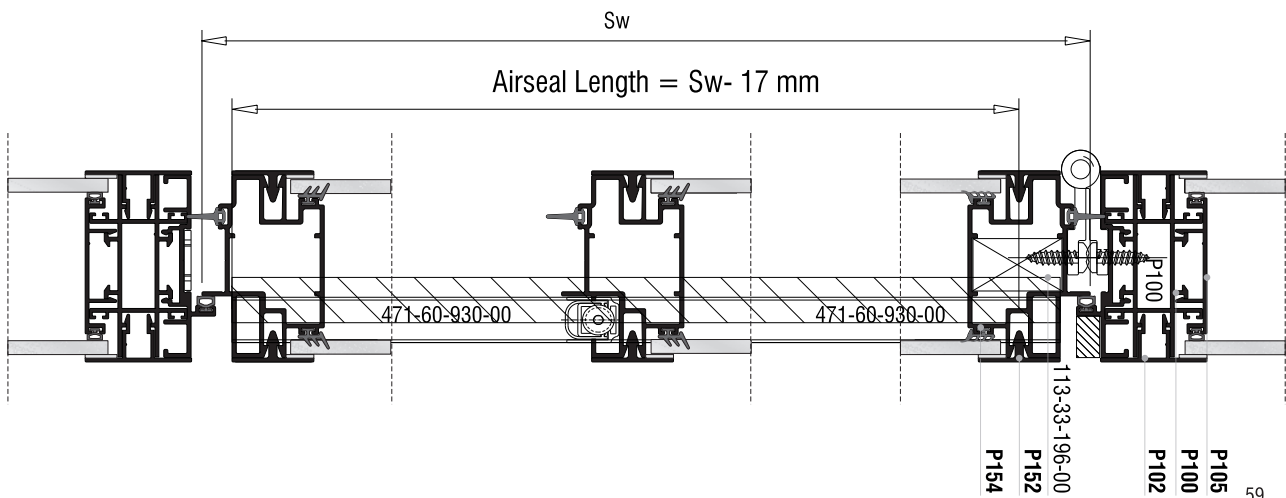
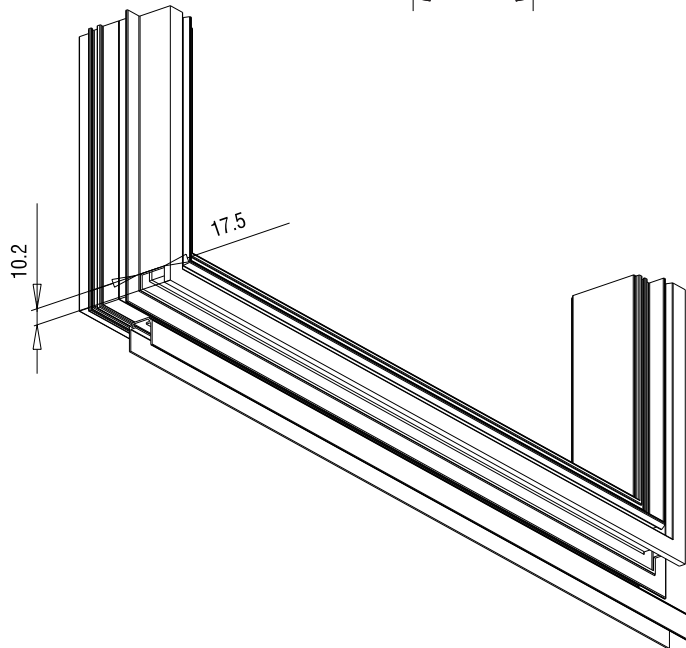
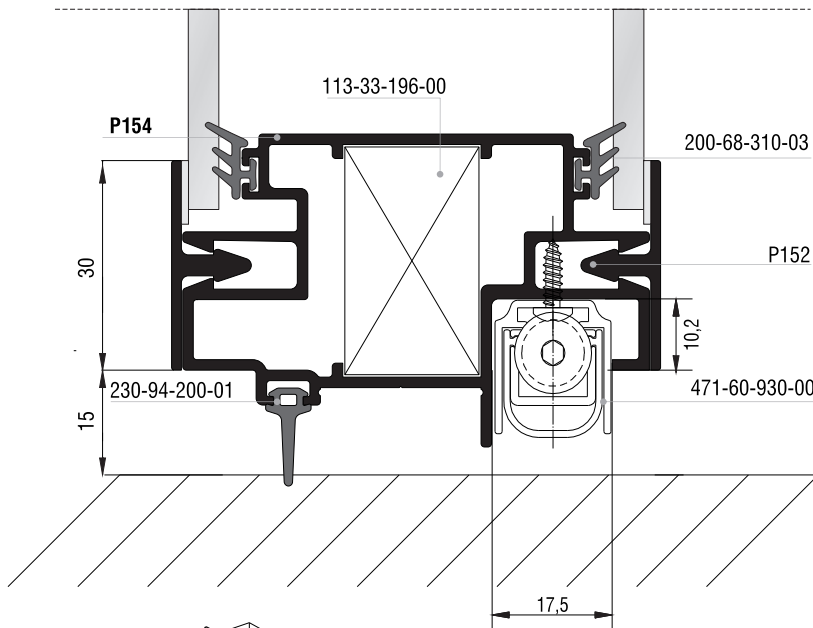

Κατεργασίες Πόρτας - Door Machinings

P152 Lock Height Inside

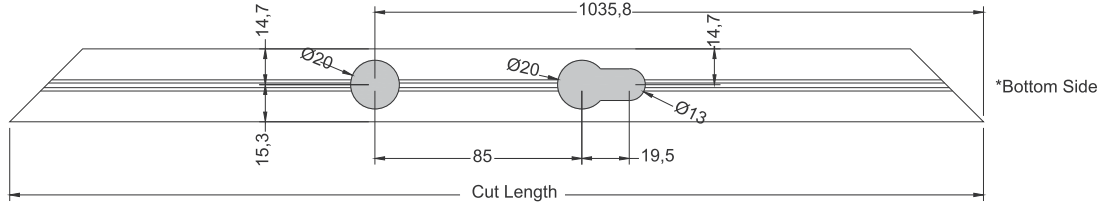
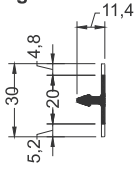

P152 Lock Height Outside

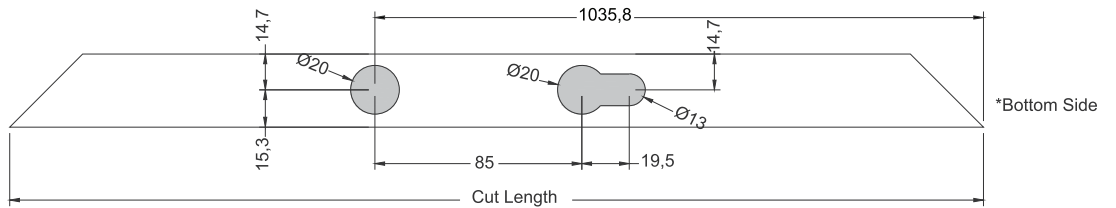
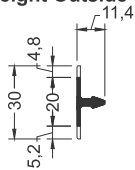

P154 Lock Height 1/2

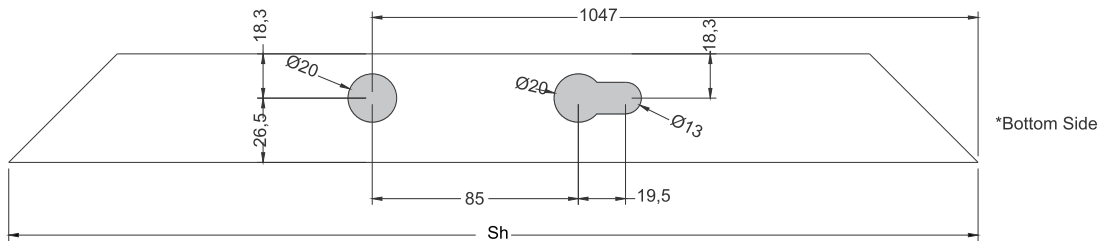
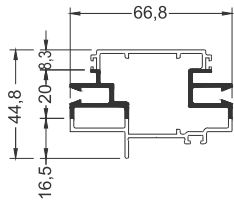

P154 Lock Height 2/2

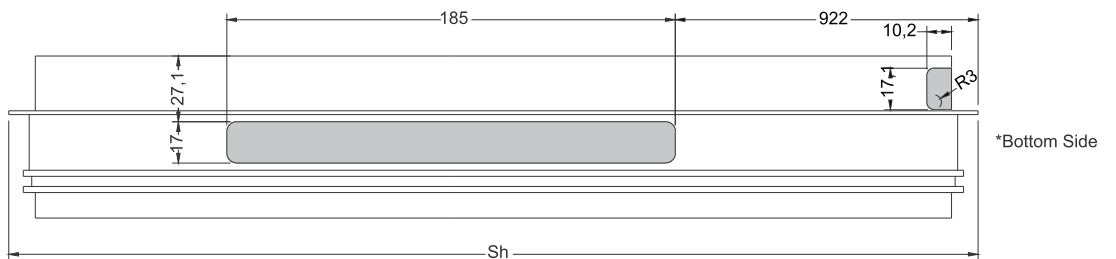
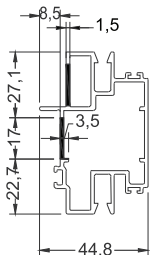

Κατεργασίες Πόρτας - Door Machinings

P154 Height

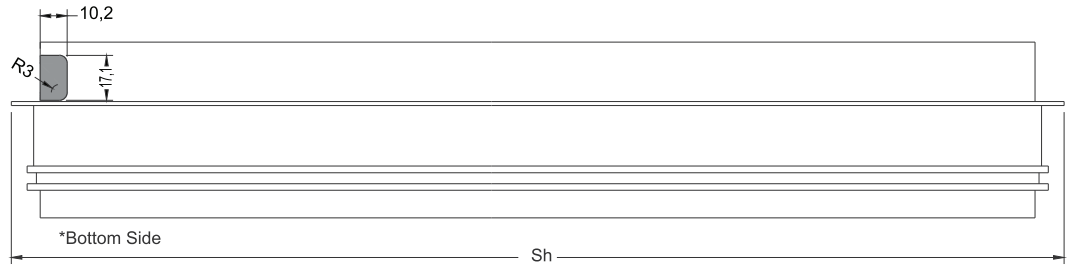
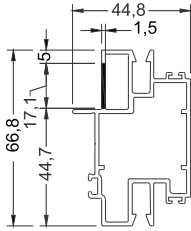

P154 Bottom Width

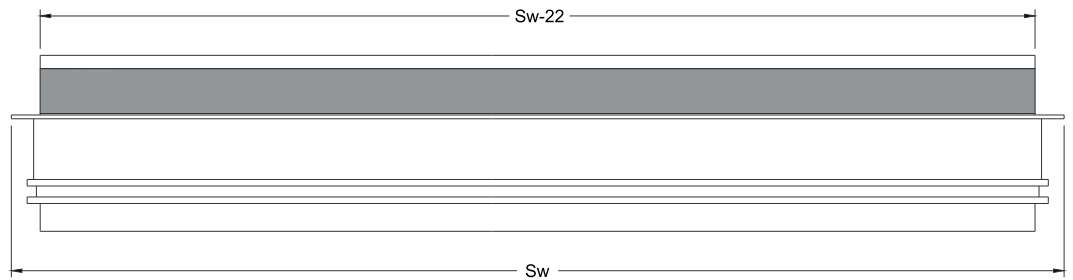
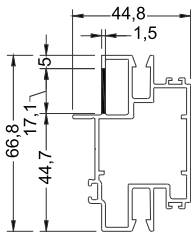

P153 Height-Strike Plate

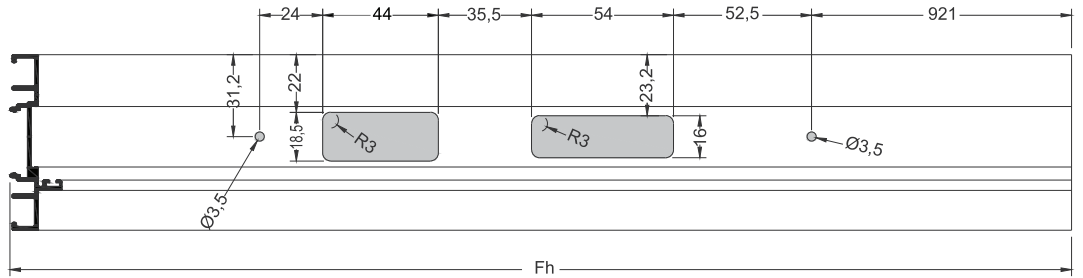
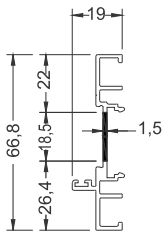

Κατεργασίες Υαλοπίνακα για Κύλινδρο - Glass Panel Machining for Cylinder

